



CAB

5148515100 - CAB-315 RE (230V 50/60) VE - ACOUSTIC CABINET FANS



Centrifugal fan cabinet with manufactured from galvanised sheet steel, acoustic and fire retardant lining 50 mm thick. Forward curved centrifugal fan with closed single-phase motor and speed controllable. IP44, F Brand S&P model CAB-315 RE (230V 50/60) VE.

Theoretical Working Point

Airflow	-
Static Pressure	0,000 Pa
Temperature	20 °C
Altitude	0 m
Density	1,2 kg/m ³
Frequency	50 Hz

Construction

Discharge diameter	315 mm
Fan size	315
Weight	33,00 kg

Motor Characteristics

Number of poles	4
Voltage	1-230V-50Hz
Maximum absorbed current	1,5 A
IP Rating	IP44
Motor insulation class	F



CAB

5148515100 - CAB-315 RE (230V 50/60) VE - ACOUSTIC CABINET FANS



Performance Chart

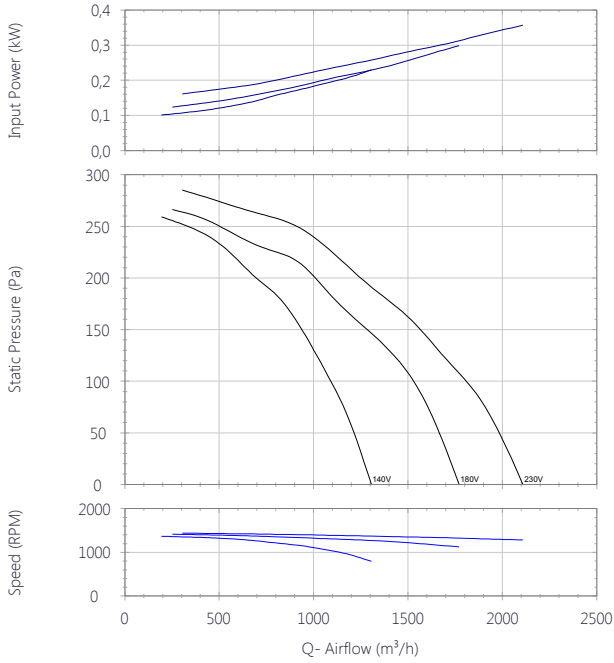

Drawing

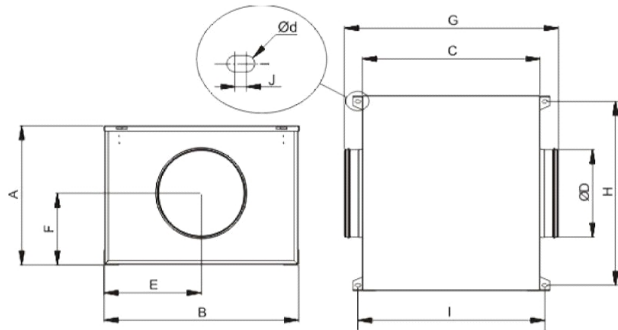

A	B	C	D	E	F	G	H	I
443	600	505	315	301	264	615	567	534

J	Ød
6.5	4.5

Sound Performance

	63	125	250	500	1k	2k	4k	8k	Overall
Inlet (LwA)	55	59	60	55	57	55	50	41	65
Inlet LpA @ 3m	34	38	39	34	36	34	29	20	45
Outlet (LwA)	59	63	64	70	74	71	67	62	78
Outlet LpA @ 3m	38	42	43	49	53	50	46	41	57
Breakout (LwA)	52	59	54	51	52	51	49	32	62
Breakout LpA @ 3m	31	38	33	30	31	30	28	11	42



Q=1



Performance Chart

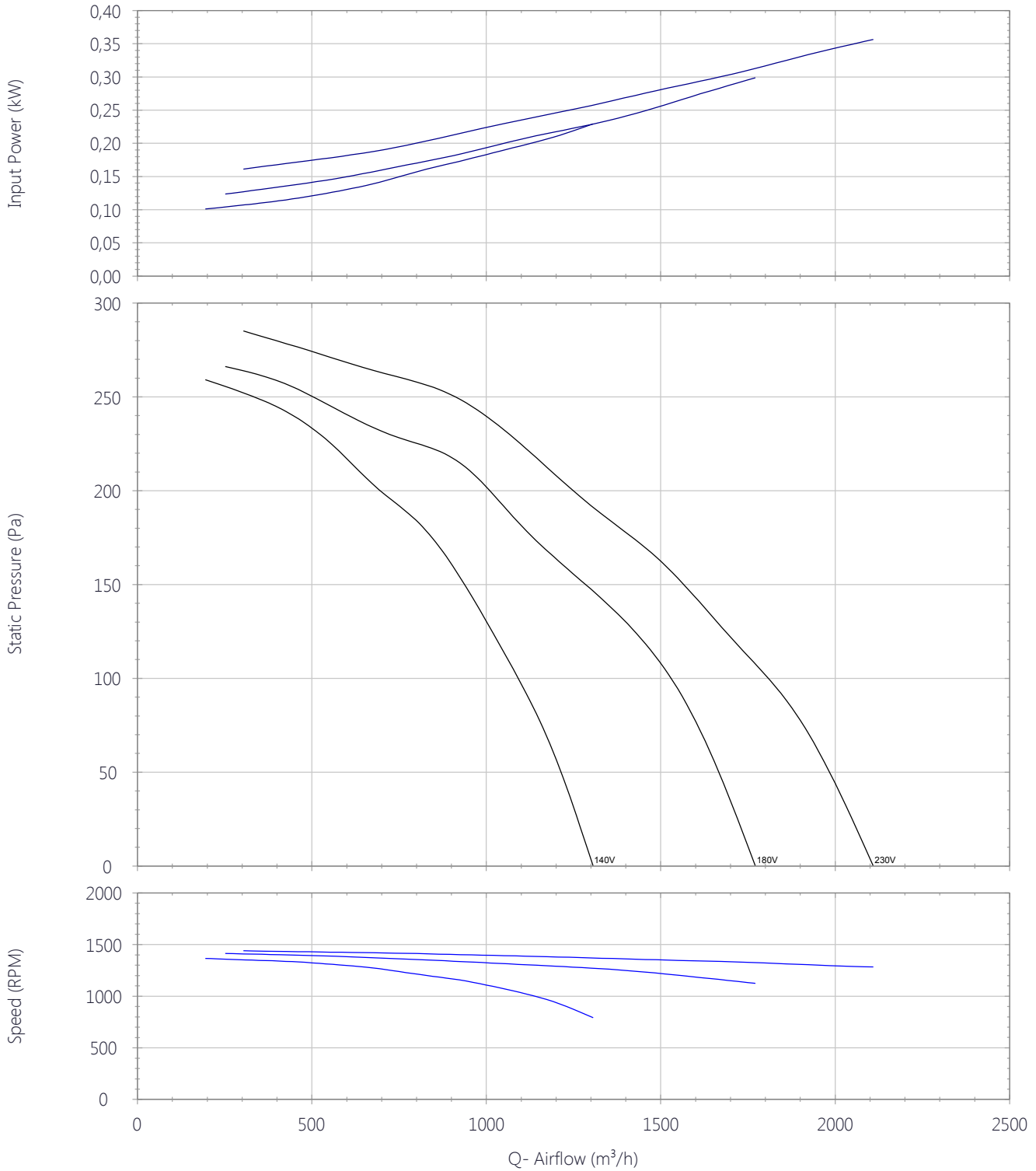



Sound Performance

	63	125	250	500	1k	2k	4k	8k	Overall
Inlet (LwA)	55	59	60	55	57	55	50	41	65
Inlet LpA @ 3m	34	38	39	34	36	34	29	20	45
Outlet (LwA)	59	63	64	70	74	71	67	62	78
Outlet LpA @ 3m	38	42	43	49	53	50	46	41	57
Breakout (LwA)	52	59	54	51	52	51	49	32	62
Breakout LpA @ 3m	31	38	33	30	31	30	28	11	42



Drawing

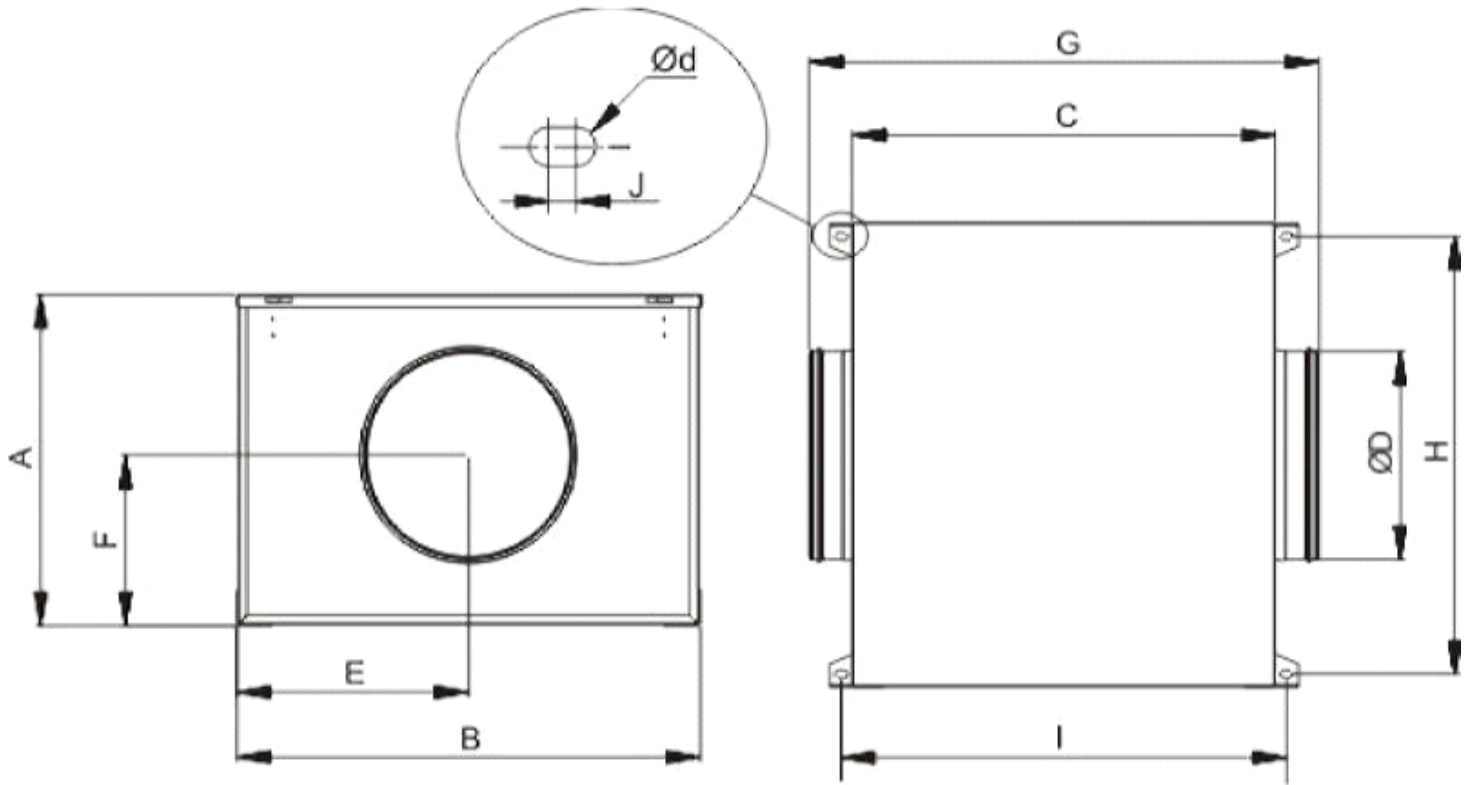

A	B	C	D	E	F	G	H	I	J	Ød
443	600	505	315	301	264	615	567	534	6.5	4.5

Accessories

5401620900 - CONTROL ECOWATT AC/4A (230VAC 50HZ)



Control element for demand controlled ventilation systems in public, commercial residential building it automatically modifies the fan speed to adapt it to the needs defined in the system, measured with sensors. It has three basic modes of operation: 1. Integral proportional control at constant pressure. 2. Proportional control with maximum demand criteria with multiple sensor input: temperature, CO2 and relative humidity. 3. Minimum-maximum control with three-sensor input: CO2, temperature, relative humidity or presence detectors (PIR). DC signal output of 1 to 10 V or signal output for AC voltage variation for single phase motors at 230 V. ECOWATT C CONTROL: for single phase ventilation units. ECOWATT C CONTROL: for DC ventilation units. Power supply: - AC model: 1~230 V. - DC model: 1~230 V or 24 VDC..

Dimensions

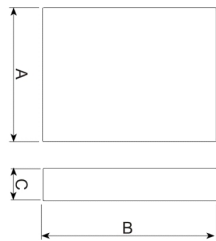

B	H	T
165	220	110

5401306500 - COM-3

Three-speed switch.Fan ON/OFF and speed selector.Maximum current rating 4A.



Dimensions

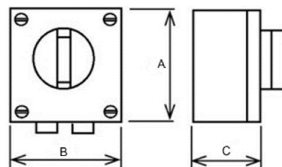

A	B	C
90	90	75

L011100000076 - REB-3 230V 50/60 ELECTRONIC SPEED CONTROLLER

Electronic single phase speed controller, 3-wire control, surface mounted, fuse protected with separate on/off switch.



Dimensions

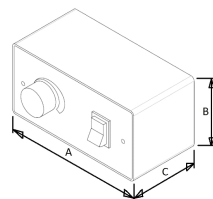

A	B	C
120	100	41

5401272900 - REB-2.5 N (230V 50)



Electronic speed controller

Dimensions

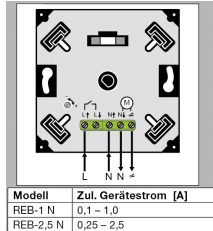

A	B	C
80	22	46

5401273700 - REB-2.5 N E (230V 50)



Electronic speed controller

5401246300 - RMB-3,5 (220V 50Y60)



AUTOTRANSFORMER SPEED CONTROLLER

Dimensions

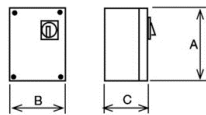

A	B	C
230	180	95

5211805600 - MBE-315/90T 3/400V



Electric Heater Battery

Dimensions

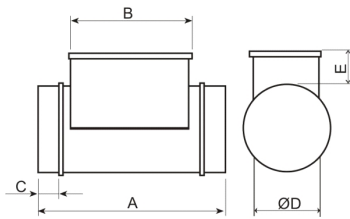

A	B	C	D	E
400	285	50	315	105

5416581600 - MFL-315 G4



MFL filtration boxes are of G4 grade filtration and are designed for direct connection with standard circular ducting. The MFL-G4 filtration boxes are supplied with a cover easily removable to replace the filter.

Dimensions

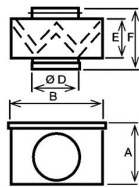

A	B	D	E	F
346	369	315	154	248

5130861700 - KSE-45

Rubber anti-vibration mounts that absorb vibration and attenuate the noise produced in the installation. (1 KSE = 4 supports in a bag)



Dimensions

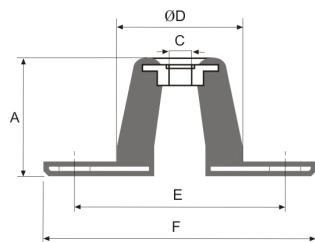

A	C	D	E	F
24	8	30	65	90

5211813000 - SIL-315

Silencer to be installed either at the inlet or outlet of the fan.



Corrections							
63	125	250	500	1k	2k	4k	8k
-0	-1	-4	-10	-12	-7	-4	-4

Dimensions

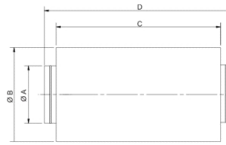

A	B	C	D
315	415	600	700

5401285100 - INTERRUPTOR PARO-MARCHA 5P

Rotatory switch. Maximum current rating 20 A. 5 wires for two speed motors. IP-66-IP-67 protection 3x380V, 440V.



Dimensions

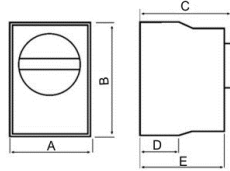

B	H	T
86	86	120

5416582400 - TG-K330 (STC)

Duct temperature sensor. Used in conjunction with electric heater and controller. NTC type with liner scale. Protection class IP20.- TG-K330: from 0 to 30°C.





CAB

5148515100 - CAB-315 RE (230V 50/60) VE - ACOUSTIC CABINET FANS

5416578200 - TG-R530 (STA)



Used in conjunction with electric heaters and controllers. NTC type with liner scale. Range of temperature 0-30°C. Protection class IP30.- Room sensor without set point adjustment, 0-30°C (TG-R530).

5132868000 - TT-S1



POWER AMPLIFIER

Dimensions

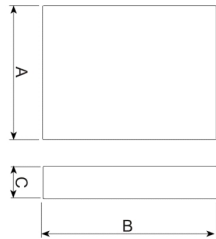

A	B	C
30	60	35

5416354800 - PULSER M



Single phase electric heater controller. Supplementary unit for slave control from another PULSER to control electric heaters with power ratings high to the PULSER capacity (3600W-230V).

Dimensions



A	B	C
83	153	40

5416365400 - PULSER-ADD



Single phase electric heater controller. Set point: 0-30°C, the sensor determines the scale range (for use with NTC-sensor). Output (load): 16 A (min. 1 A). Protection class: IP30. Input regulation maximum and minimum. Maximum absorbed power: 3.6 kW.

Dimensions



A	B	C
83	153	40

5138920900 - ACOPEL F400-315/160 N

FLEXIBLE CONNECTOR



Dimensions

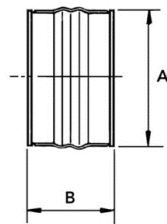

A	B
323	160

5132867200 - TTC-2000 (REG-16)



ELECTRICAL HEATER BATTERY CONTROLLER

Dimensions

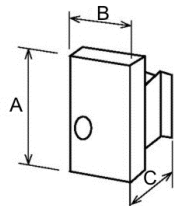

A	B	C
280	160	140

L0111000000276 - OVER RUN TIMER



Remote (wired) run-on timer, adjustable run-on time 30 seconds to 25 minutes.

Dimensions

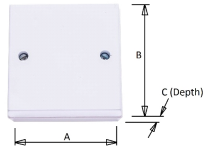

A	B	C
83	83	40

L0111000000388 - 7-DAY PROGRAMMABLE TIMECLOCK



Surface-mount digital 7-day timer.

Dimensions

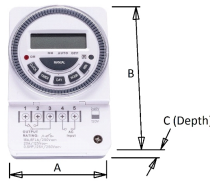

A	B	C
66	98	39

L0111000000414 - CONTACTOR INTERFACE STATION -9A-2 x N/C AND 2 x N/O CONTACTS



9A 2 x N/O / 2 x N/C relay in IP65 enclosure for switching of fans from an external source.

Dimensions

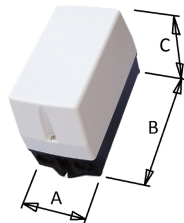

A	B	C
110	234	149

L011100000199 - CONTACTOR INTERFACE STATION - 9A – 4 x N/O CONTACTS

9A N/O relay in IP65 enclosure for switching of fans from an external source, particularly useful for the on/off control of 3-phase units.



Dimensions

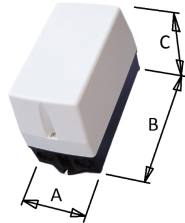

A	B	C
110	234	149

L011100000541 - RELAY 230V COIL DPDT C/W ENCLOSURE IP65

Double-Pole, Double-throw relay in IP65 enclosure for switching of fans from an external source.



Dimensions

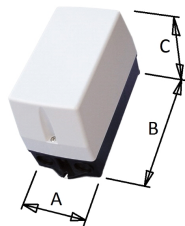

A	B	C
110	234	149

L011100000275 - PIR SENSOR

PIR SENSOR with Volt-Free contacts and adjustable timer.



Dimensions

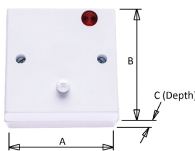

A	B	C
83	83	55

L0111000000389 - THERMOSTAT 230V INPUT



Thermostat for switching of fans by temperature, adjustable temperature range 10-30 degrees C.

Dimensions

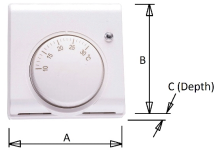

A	B	C
83	83	40

L0111000000390 - THERMOSTAT 24V INPUT



Thermostat for switching of fans by temperature, adjustable temperature range 10-30 degrees C.

Dimensions

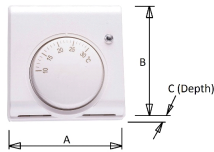

A	B	C
83	83	40

L0111000000589 - CO2 SENSOR WITH VFC (MAX 3A AT 250V) 230V



CO2 Sensor for switching of fans by Carbon Dioxide, adjustable switching points: 800ppm, 1000ppm, 1200ppm, 1400ppm.

Dimensions

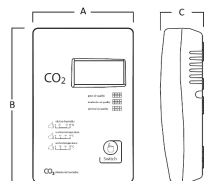

A	B	C
85	130	38.5