



COMPACT HCBB/HCBT ALUMINIUM IMPELLERS

5603638900 - HCBB/4-355/H-A (230V50HZ) V5 - PLATE MOUNTED AXIAL FLOW FANS



Range of low profile plate mounted axial fans fitted with aluminium impellers and single phase motor (HCBB), IP65, Class F insulation, equipped with thermal protection*.

*Except models Ø 800 to 1000.

Motors

Available, depending upon the model, with single or three phase motors in 4 or 6 poles. All motors are speed controllable by autotransformer except models /4-630, B/710, T/4-710, T/800, T/900 and T/1000.

Electrical supplies:

Single phase 230V-50Hz.

(Capacitor located inside the wiring terminal box).

Trade S&P model HCBB/4-355/H-A (230V50HZ) V5

Theoretical Working Point

Airflow	-
Static Pressure	0,000 Pa
Temperature	20 °C
Altitude	0 m
Density	1,2 kg/m ³
Frequency	50 Hz

Construction

Discharge diameter	355 mm
Fan size	355
Blades	7
Weight	8,00 kg

Motor Characteristics

Number of poles	4
Voltage	1-230V-50Hz
Maximum absorbed current	0,9 A
IP Rating	IP65
Motor insulation class	F

Drawing

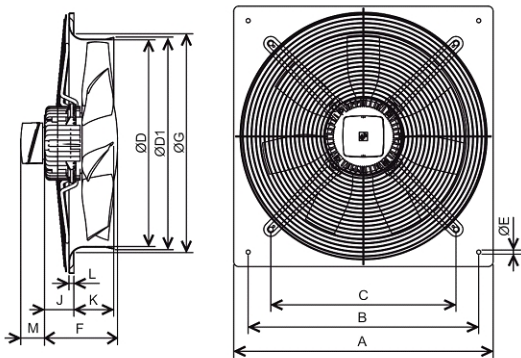

A	B	C	D	D1	E	F	G	J
450	380	315	355	363	10	129	371	45

K	L	M
75	12	65

Performance Chart

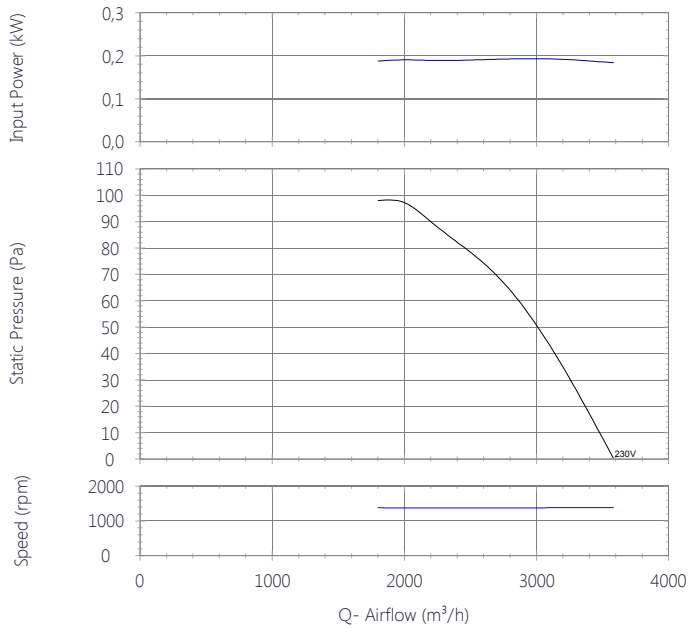

Sound Performance

	63	125	250	500	1k	2k	4k	8k	Overall
Inlet (LwA)	42	57	56	64	69	65	60	53	72
Inlet LpA @ 1m	31	46	45	53	58	54	49	42	61





COMPACT HCBB/HCBT ALUMINIUM IMPELLERS

5603638900 - HCBB/4-355/H-A (230V50HZ) V5 - PLATE MOUNTED AXIAL FLOW FANS

Performance Chart

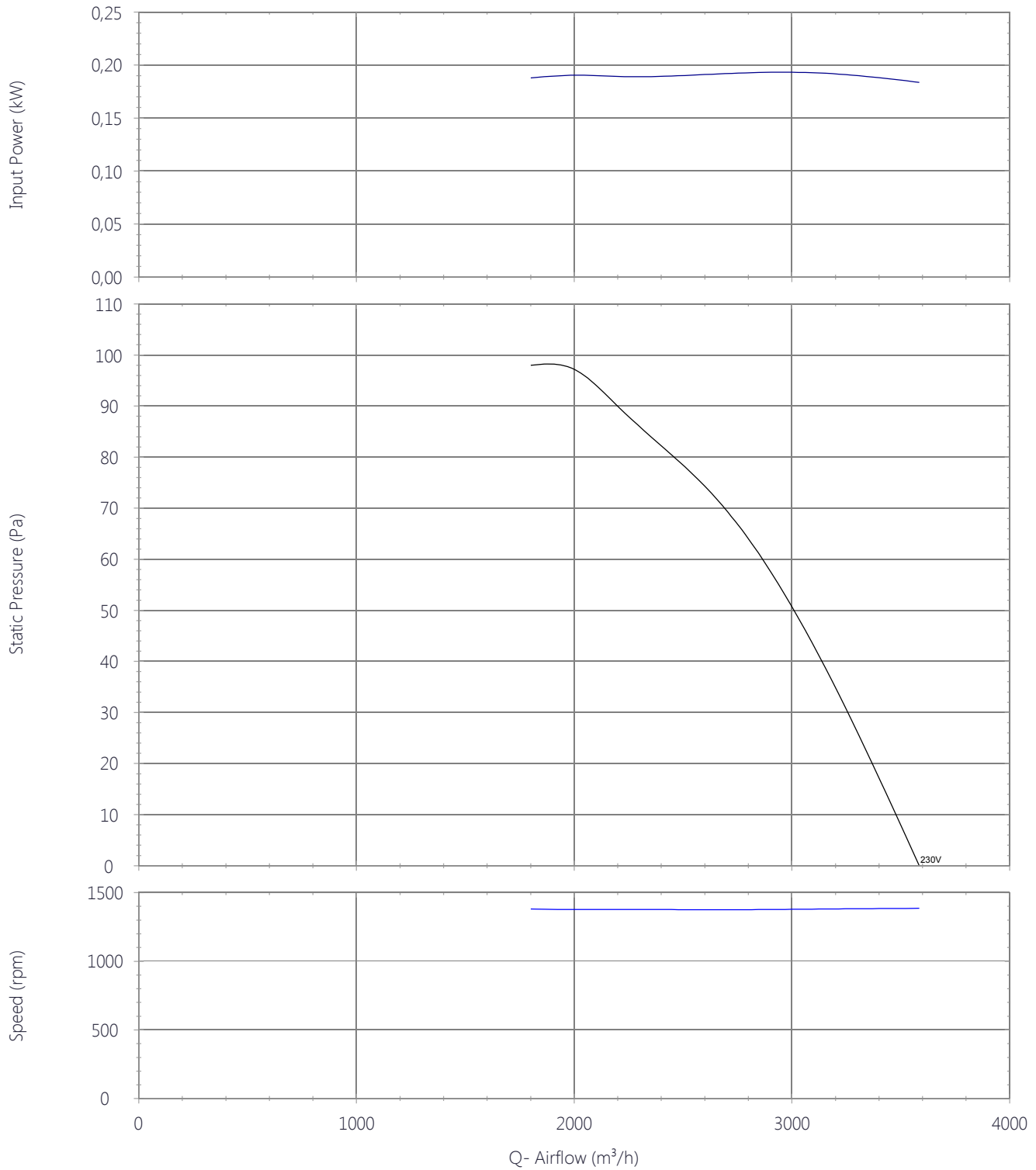



COMPACT HCBB/HCBT ALUMINIUM IMPELLERS

5603638900 - HCBB/4-355/H-A (230V50HZ) V5 - PLATE MOUNTED AXIAL FLOW FANS

Drawing

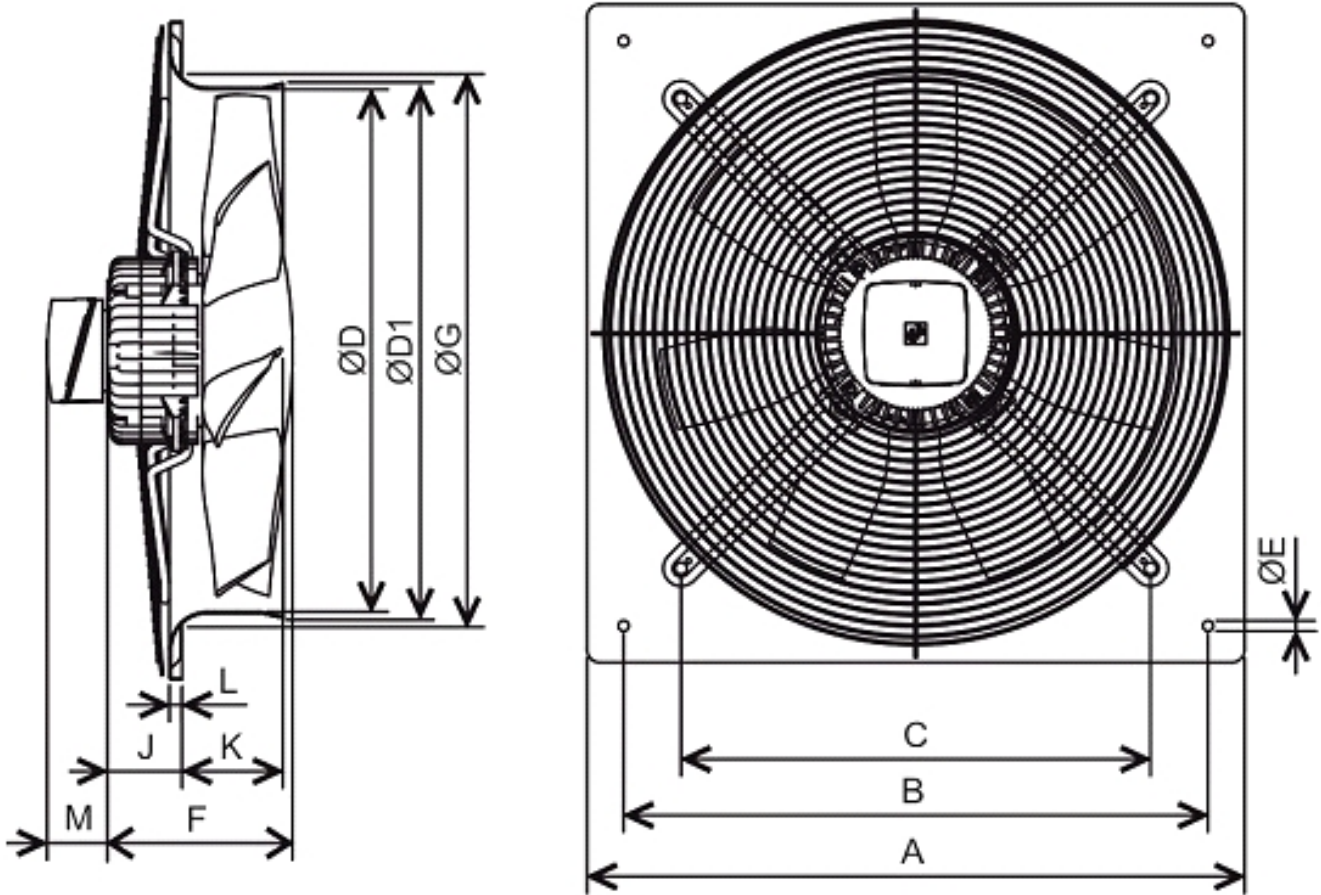

A	B	C	D	D1	E	F	G	J	K	L	M
450	380	315	355	363	10	129	371	45	75	12	65



COMPACT HCBB/HCBT ALUMINIUM IMPELLERS

5603638900 - HCBB/4-355/H-A (230V50HZ) V5 - PLATE MOUNTED AXIAL FLOW FANS

Accessories

L011100000539 - 6-WAY EXPANSION BOX



Expansion Box for control of fans by multiple sensor input, must be used in conjunction with Over-run timer S&P100000276.

Dimensions

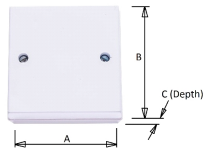

A	B	C
83	83	40

5112640700 - DEF-375 DESCARGA

WIRE PROTECTION GUARD - PLATE AXIAL FANS



Dimensions

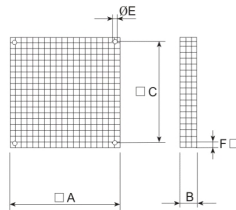

A	B	C	E	F
449	64	403	8	10.6

5112681300 - PER-355 CR

Louvre back draft shutters with steel frame and aluminium shutter blades with a system for simultaneous opening of all shutter blades. All models are fitted with bird guard.



Dimensions

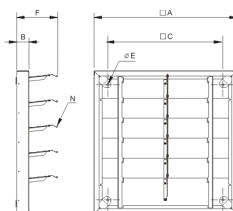

A	B	C	E	F	N
450	60	352	8	146	5



COMPACT HCBB/HCBT ALUMINIUM IMPELLERS

5603638900 - HCBB/4-355/H-A (230V50HZ) V5 - PLATE MOUNTED AXIAL FLOW FANS

5406061100 - PER-355 W

Louvre back draft shutters manufactured totally from UV stabilized plastic material.



Dimensions

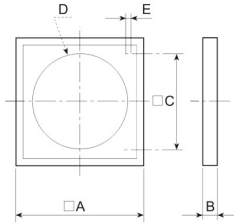

A	B	C	D	E
394	26	310	360	5

L011100000276 - OVER RUN TIMER

Remote (wired) run-on timer, adjustable run-on time 30 seconds to 25 minutes.



Dimensions

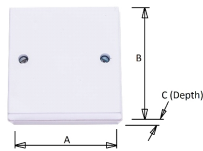

A	B	C
83	83	40

L011100000388 - 7-DAY PROGRAMMABLE TIMECLOCK

Surface-mount digital 7-day timer.



Dimensions

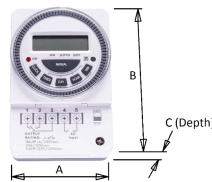

A	B	C
66	98	39



COMPACT HCBB/HCBT ALUMINIUM IMPELLERS

5603638900 - HCBB/4-355/H-A (230V50HZ) V5 - PLATE MOUNTED AXIAL FLOW FANS

L011100000414 - CONTACTOR INTERFACE STATION -9A - 2xN/C & 2xN/O CONTACTS

9A 2 x N/O / 2 x N/C relay in IP65 enclosure for switching of fans from an external source.



Dimensions

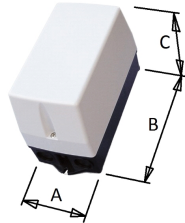

A	B	C
110	234	149

L011100000199 - CONTACTOR INTERFACE STATION -9A - 4xN/O CONTACTS

9A N/O relay in IP65 enclosure for switching of fans from an external source, particularly useful for the on/off control of 3-phase units.



Dimensions

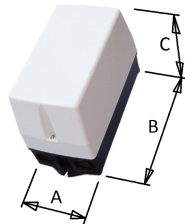

A	B	C
110	234	149

L011100000541 - RELAY 230V COIL DPDT C/W ENCLOSURE IP65

Double-Pole, Double-throw relay in IP65 enclosure for switching of fans from an external source.



Dimensions

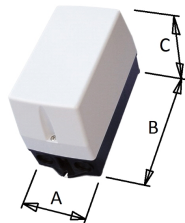

A	B	C
110	234	149



COMPACT HCBB/HCBT ALUMINIUM IMPELLERS

5603638900 - HCBB/4-355/H-A (230V50HZ) V5 - PLATE MOUNTED AXIAL FLOW FANS

L011100000275 - PIR SENSOR



PIR SENSOR with Volt-Free contacts and adjustable timer.

Dimensions

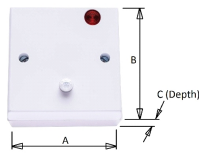

A	B	C
83	83	55

L011100000389 - THERMOSTAT 230V INPUT



Thermostat for switching of fans by temperature, adjustable temperature range 10-30 degrees C.

Dimensions

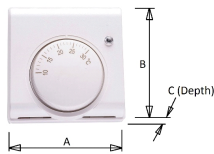

A	B	C
83	83	40

L011100000390 - THERMOSTAT 24V INPUT



Thermostat for switching of fans by temperature, adjustable temperature range 10-30 degrees C.

Dimensions

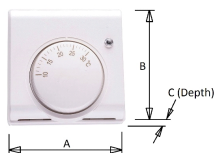

A	B	C
83	83	40



COMPACT HCBB/HCBT ALUMINIUM IMPELLERS

5603638900 - HCBB/4-355/H-A (230V50HZ) V5 - PLATE MOUNTED AXIAL FLOW FANS

L0111000000589 - CO2 SENSOR WITH VFC (MAX 3A AT 250V) 230V



CO2 Sensor for switching of fans by temperature, adjustable switching points: 800ppm, 1000ppm, 1200ppm, 1400ppm.

Dimensions

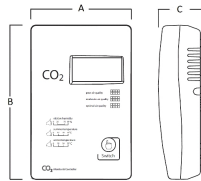

A	B	C
85	130	38.5



COMPACT HCBB/HCBT ALUMINIUM IMPELLERS

5603638900 - HCBB/4-355/H-A (230V50HZ) V5 - PLATE MOUNTED AXIAL FLOW FANS

Sound Performance

	63	125	250	500	1k	2k	4k	8k	Overall
Inlet (LwA)	42	57	56	64	69	65	60	53	72
Inlet LpA @ 1m	31	46	45	53	58	54	49	42	61





COMPACT HCBB/HCBT ALUMINIUM IMPELLERS

5603638900 - HCBB/4-355/H-A (230V50HZ) V5 - PLATE MOUNTED AXIAL FLOW FANS

ErP Data

Maximum efficiency %	29,1
Installation type	A
Category efficiency	Static
N	N40
Variable speed drive	+
Year of manufacture	Product Rating Plate
Manufacturer's Info	S&P ES-08150 CIF-864911928
Product code	5603638900
Input power at optimum efficiency point (kW)	0,189
Airflow at optimum efficiency point [m ³ /h]	2.300
Pressure at optimum efficiency point [Pa]	86
Speed at optimum efficiency point	1377
Specific Ratio	1
Recycling/disposal	Instruction Manual
Maintenance	Instruction Manual
Additional components	Catalogue and according to ISO 5801