



# COMPACT HCFB/HCFT PLASTIC IMPELLERS

5602186800 - HCFT/4-315/H-A (230/400V50HZ) VE - PLATE MOUNTED AXIAL FLOW FANS



Range of low profile plate mounted axial fans fitted with plastic impellers with fiberglass, three phase motor (HCFT), IP65, Class F insulation, equipped with thermal protection.

## Motors

4 poles. Motor is speed controllable by autotransformer.  
 Electrical supplies:  
 Three phase 230/400V-50Hz or 400V-50Hz.  
 Brand S&P model HCFT/4-315/H-A (230/400V50HZ) VE.

## Theoretical Working Point

Airflow	-
Static Pressure	0,000 Pa
Temperature	20 °C
Altitude	0 m
Density	1,2 kg/m <sup>3</sup>
Frequency	50 Hz

## Construction

Discharge diameter	315 mm
Fan size	315
Blades	7
Weight	7,00 kg

## Motor Characteristics

Number of poles	4
Voltage	3-230/400V-50Hz
Maximum absorbed current	0,5 A / 0,3 A
IP Rating	IP65
Motor insulation class	F

## Drawing

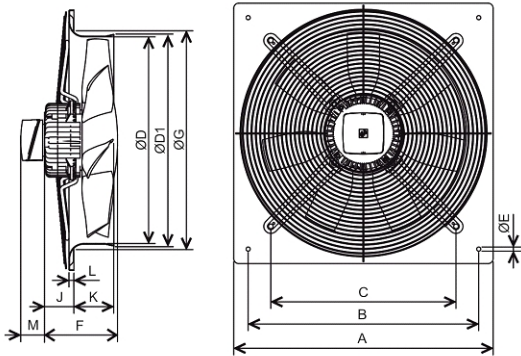

A	B	C	D	D1	E	F	G	J
400	330	280	315	320	10	122	329	32
K	L	M						
68	12	60						

## Performance Chart

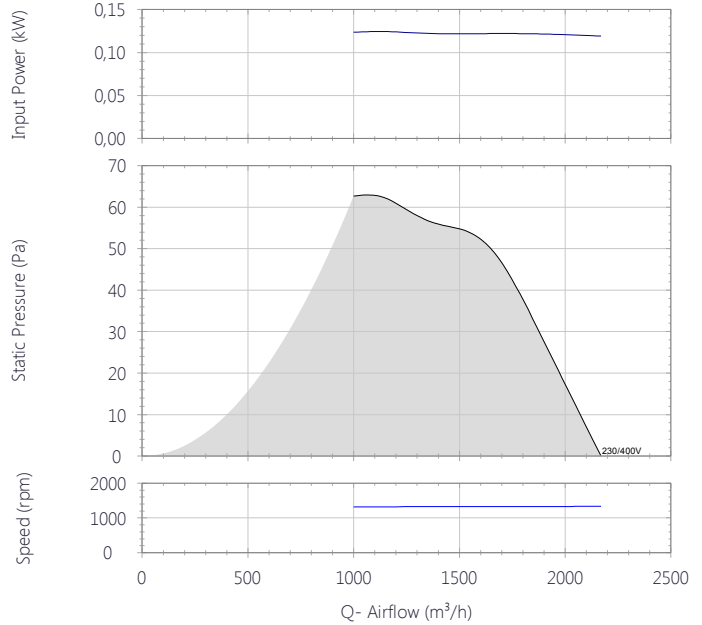

## Sound Performance

	63	125	250	500	1k	2k	4k	8k	Overall
Inlet (LwA)	42	53	60	62	64	62	56	50	69
Inlet LpA @ 1m	32	43	50	52	54	51	45	39	58





# COMPACT HCFB/HCFT PLASTIC IMPELLERS

5602186800 - HCFT/4-315/H-A (230/400V50HZ) VE - PLATE MOUNTED AXIAL FLOW FANS

Performance Chart

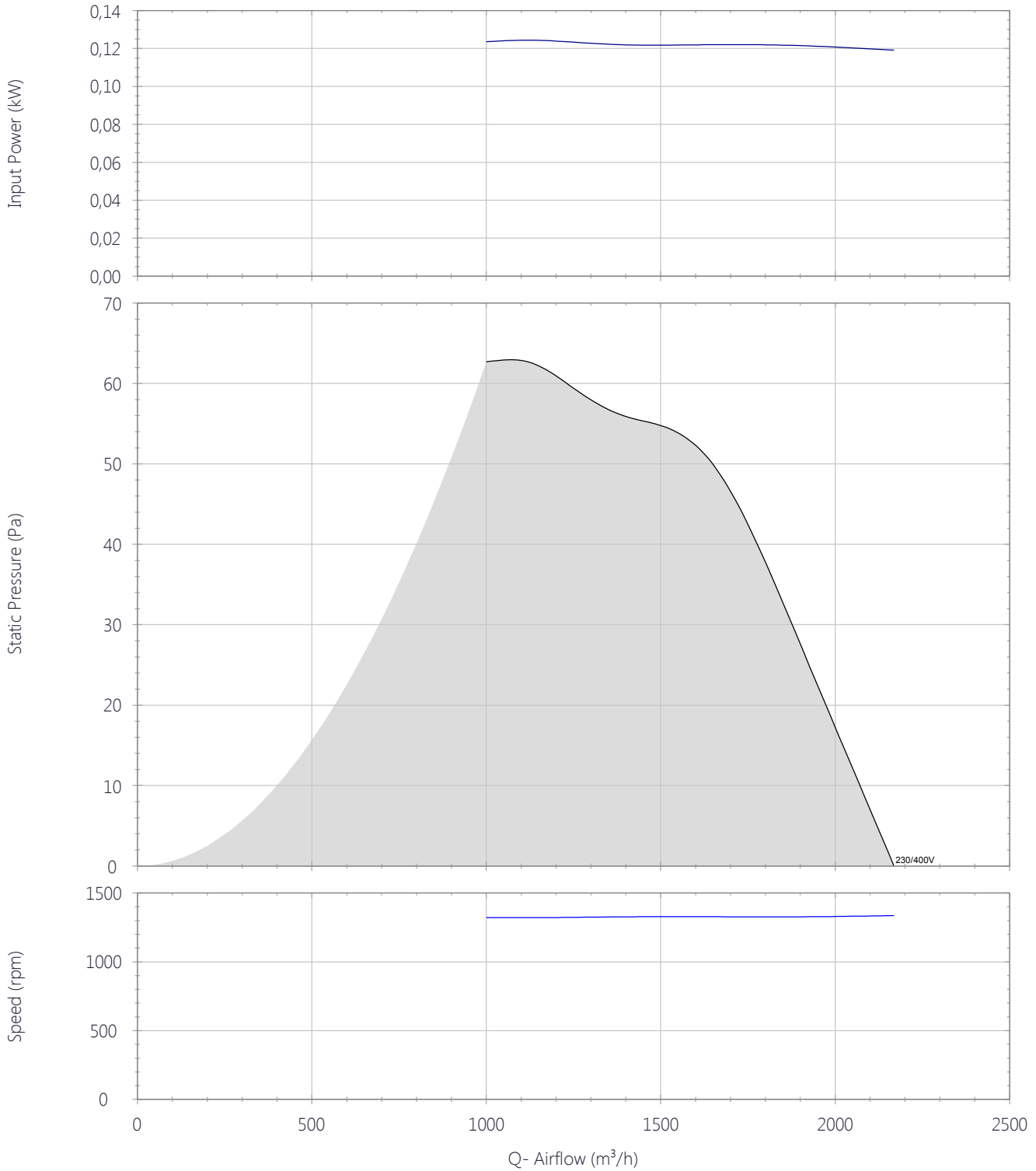



# COMPACT HCFB/HCFT PLASTIC IMPELLERS

5602186800 - HCFT/4-315/H-A (230/400V50HZ) VE - PLATE MOUNTED AXIAL FLOW FANS

Drawing

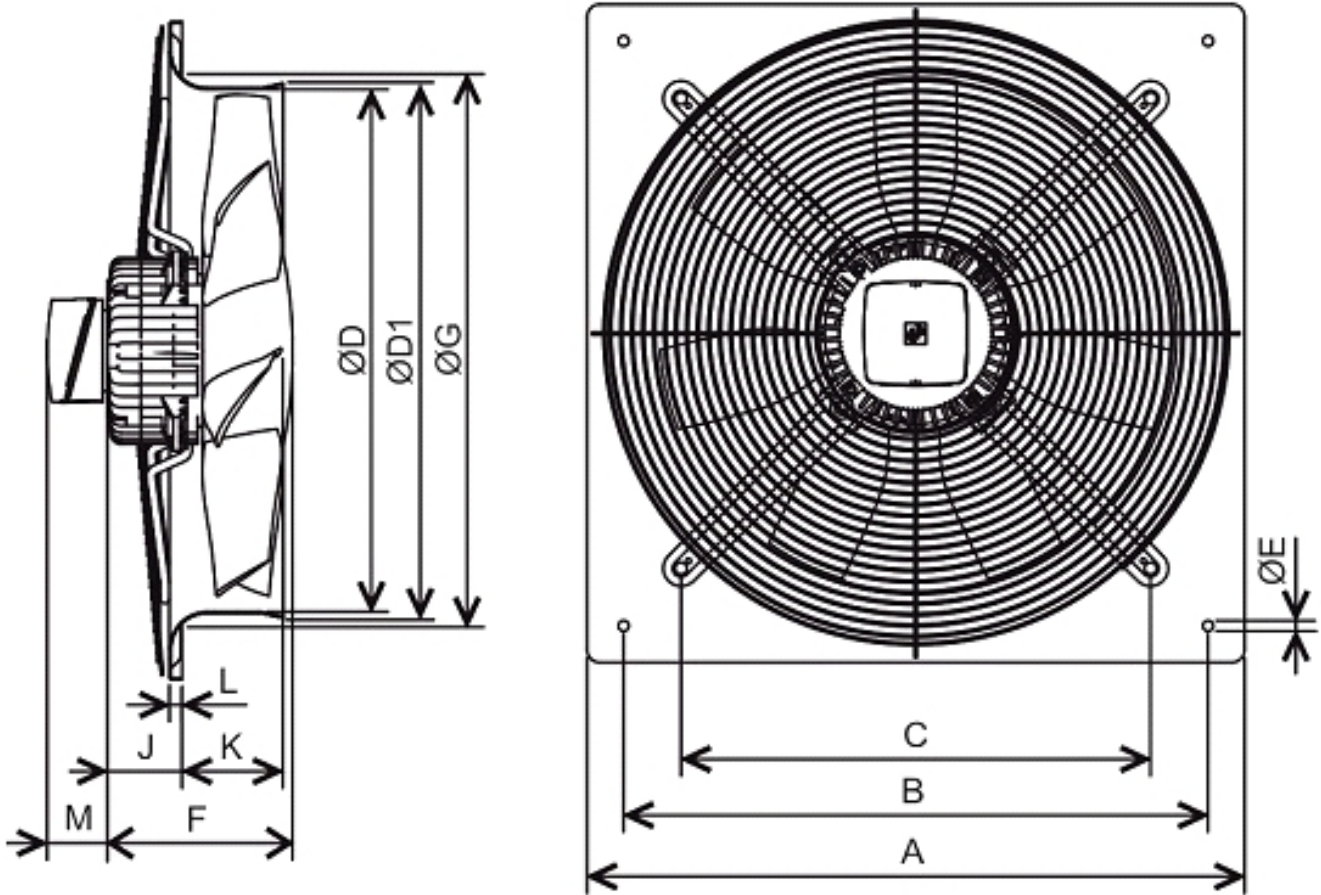

A	B	C	D	D1	E	F	G	J	K	L	M
400	330	280	315	320	10	122	329	32	68	12	60



# COMPACT HCFB/HCFT PLASTIC IMPELLERS

5602186800 - HCFT/4-315/H-A (230/400V50HZ) VE - PLATE MOUNTED AXIAL FLOW FANS

## Accessories

L1000000662 - S&P UK DIGITAL INVERTER VFD-M 1PH>3PH 2.2KW 230V (10A MAX)



Single-phase 230V-50/60Hz Voltage supply. Motor kW protection programmable by a single parameter. Power on and drive status indication. Speed selection with UP/DOWN keys. Run/Fault relay output contacts. Motor overload and shortcut protections.

### Dimensions

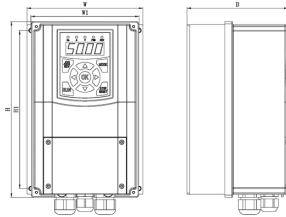

H	H1	W	W1	D	d
193	170	150	140	131	4.5

5401611900 - VFTM MONO 0,18 Modelo ATV312



Adjustable frequency drive IP65. Single phase supply (230V 50/60Hz), three phase 230V output .

### Dimensions

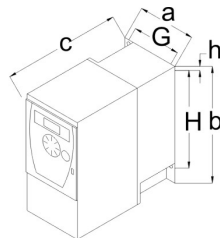

a	b	c	G	H
72	145	132	60	121.5

5401618200 - VFTM MONO 0,18 IP55



Adjustable frequency drive. Single phase supply (230V 50/60Hz), three phase 230V output .

### Dimensions

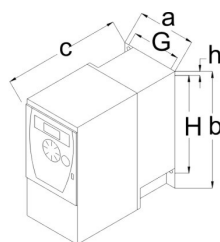

a	b	c	G	H	I
210	240	163	192	218	5.5



# COMPACT HCFB/HCFT PLASTIC IMPELLERS

5602186800 - HCFT/4-315/H-A (230/400V50HZ) VE - PLATE MOUNTED AXIAL FLOW FANS

L1000000664 - S&P UK DIGITAL INVERTER VFD-T 3PH>3PH 2.2KW 400V (5A MAX)

Three-phase 400V-50/60Hz Voltage supply. Motor kW protection programmable by a single parameter. Power on and drive status indication. Speed selection with UP/DOWN keys. Run/Fault relay output contacts. Motor overload and shortcut protections.



## Dimensions

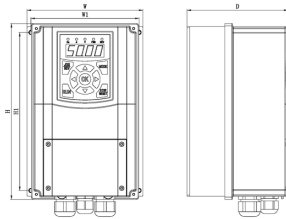

H	H1	W	W1	D	d
193	170	150	140	131	4.5

5401612600 - VFTM TRI 0,37

Adjustable frequency drive. Three phase supply (400V 50/60Hz), three phase 400V output.



## Dimensions

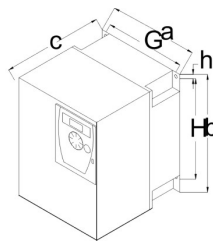

a	b	c	G	h	H	I	nM4
107	143	152	93	5	121.5	5	2

5401618900 - VFTM TRI 0,37 IP55

Adjustable frequency drive IP65. Three phase supply (400V 50/60Hz), three phase 400V output.



## Dimensions

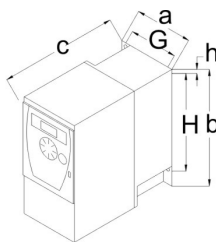

a	b	c	G	H	I
215	297	192	197	277	5.5



# COMPACT HCFB/HCFT PLASTIC IMPELLERS

5602186800 - HCFT/4-315/H-A (230/400V50HZ) VE - PLATE MOUNTED AXIAL FLOW FANS

5132926600 - MSD



Motor starter for three phase motors with integrated thermal contacts.- Surface mounting.- Cabinet installation. - Potential free contact. - IP54.

5112635700 - DEF-325 DESCARGA



WIRE PROTECTION GUARD

### Dimensions

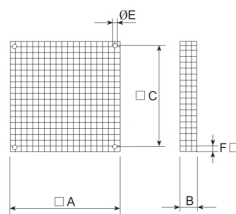

A	B	C	E	F
397	64	351	8	10.6

5112681300 - PER-355 CR



Louvre back draft shutters with steel frame and aluminium shutter blades with a system for simultaneous opening of all shutter blades. All models are fitted with bird guard.

### Dimensions

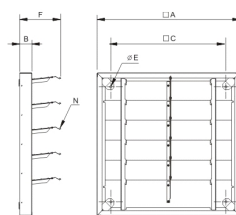

A	B	C	E	F	N
450	60	352	8	146	5



# COMPACT HCFB/HCFT PLASTIC IMPELLERS

5602186800 - HCFT/4-315/H-A (230/400V50HZ) VE - PLATE MOUNTED AXIAL FLOW FANS

5406061100 - PER-355 W



Louvre back draft shutters manufactured totally from UV stabilized plastic material.

### Dimensions

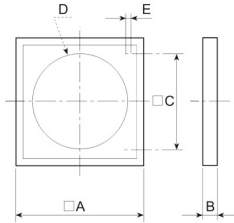

A	B	C	D	E
394	26	310	360	5

5401257000 - CONMUTADOR TRIANGULO/ESTRELLA



Three phase fan Y / Δ switch. Rotary switch with three positions, OFF, Y and Δ. IP67 protection. Maximum absorbed current: 20A.

### Dimensions

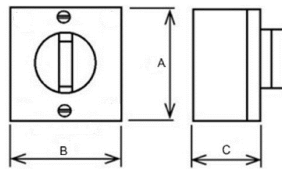

B	H	T
86	120	105



# COMPACT HCFB/HCFT PLASTIC IMPELLERS

5602186800 - HCFT/4-315/H-A (230/400V50HZ) VE - PLATE MOUNTED AXIAL FLOW FANS

## Sound Performance

	63	125	250	500	1k	2k	4k	8k	Overall
Inlet (LwA)	42	53	60	62	64	62	56	50	69
Inlet LpA @ 1m	32	43	50	52	54	51	45	39	58







# COMPACT HCFB/HCFT PLASTIC IMPELLERS

5602186800 - HCFT/4-315/H-A (230/400V50HZ) VE - PLATE MOUNTED AXIAL FLOW FANS

## ErP Data

Maximum efficiency %	19,1
Installation type	A
Category efficiency	Static
N	N31,2
Variable speed drive	+
Year of manufacture	Product Rating Plate
Manufacturer's Info	S&P ES-08150 CIF-864911928
Product code	5602186800
Input power at optimum efficiency point (kW)	0,122
Airflow at optimum efficiency point [m3/h]	1,575
Pressure at optimum efficiency point [Pa]	53
Speed at optimum efficiency point	1328
Specific Ratio	1
Recycling/disposal	Instruction Manual
Maintenance	Instruction Manual
Additional components	Catalogue and according to ISO 5801