

EuroSeries[®] (ESP)

- Die cast aluminium impellers
- Fully speed controllable
- Air Volumes up to 13.89m³/s
- Sizes 250 to 1000 dia protected to IP54
- Operating Temperatures from -40°C up to +70°C Motor
- Insulation Class F
- Thermal overload for motor protection
- Reversible - Supply or Extract
- Tough epoxy paint finish
- Quality Assurance to BS EN ISO 9001:1994
- Performance tested to ISO 5801



The EuroSeries[®] ESP axial blade plate fans, feature a single shot die cast aluminium blade and external rotor motor design.

The EuroSeries[®] ESP range is available in eleven sizes with the extract performances up to 13.89m³/s, with pressure characteristics of up to 300Pa. All units are designed for speed controllable.

Impellers

All sizes are supplied with cast aluminium impellers, ensuring performance when working against outdoor conditions and abrasive airflow. Where fans are reversible for Intake a -30% drop in performance can be expected.

Motors

External rotor motors are specially designed and styled for this range of fan. Ball bearings are greased for life. Rotors are dynamically balanced to ISO 1940. Sizes 250-1000mm, motors are protected to IP54, against dust and moisture complying with BS EN 60529:1992. They are ribbed aluminium body castings for efficient cooling. Motor insulation is Class 'F' (from -40°C to +70°C).

Electrical

Single phase 220-240V 50Hz. Capacitor start and run. Three phase 380-415V 50Hz. An IP54 terminal box are supplied with 20mm and PGII entry. All motors are fitted with thermal overload protection which should be wired into all controller circuits and into starter contactors. Models are available with either 2,4,6 or 8 pole motors.

Terminal Box

Terminal Box to IP54 as standard, protected against dust and water from any angle allowing outside applications.

Performance

The fan performance is in accordance with tests to BS848 Part 1 1980.

Sound Levels

Fan sound levels are measured in a reverberant chamber in accordance with BS848 Part 2 1985. Published dB(A) figures are free field sound pressure levels at 3m with spherical propagation at a reference level of 2×10^{-5} Pa (20 micro-Pascal). The sound power level spectra figures are dB with reference level of 10^{-12} Watts (1 pico-watt). To ensure minimum noise levels during speed control, an auto transformer speed control is recommended.

Accessories

A full range of accessories:

- Electronic Speed Controllers
- Auto Transformer Speed Controllers
- D.O.L. Starters & Overloads
- Discharge Guards
- Louvre Shutters

Dimensions (mm)

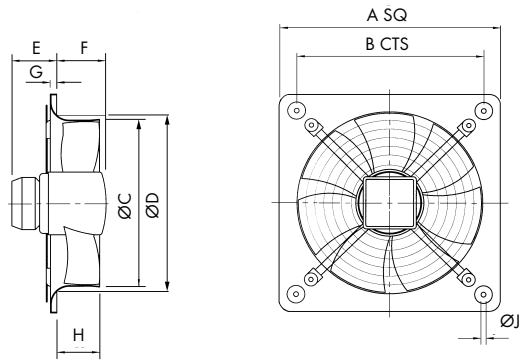

Dia	A	B	ØC	ØD	E	F	G	H	ØJ	kg
250	370	320	256.5	264.5	84	80	6	80	9	3.4
315	430	380	320	328	84	84	19	70	9	6.3
355	485	435	367	372	86	97	21	75	9	7.3
400	540	490	412	420	93	100	12	88	9	10.2
450	575	535	463	480	86	139	14	96	11	15.8
500	655	615	517	528	84	141	16	104	11	17.3
560	725	675	568	589	81	142.5	16	119	11	24
630	805	750	643	664	82	142.5	20	130	11	45
710	850	810	720	763	37	176.5	20	150	14.5	31
800	970	910	804	869	34	244	17	193	14.5	38
1000	1170	1110	1009	1067	40	284	20	200	14.5	84

Performance Guide

250 to 315 dia. - 1 Phase - 2 & 4 Pole

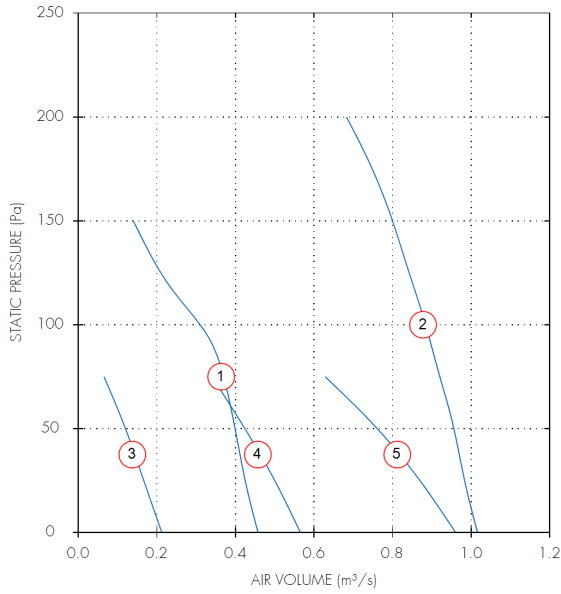

250 to 315 dia. - 3 Phase - 2 & 4 Pole

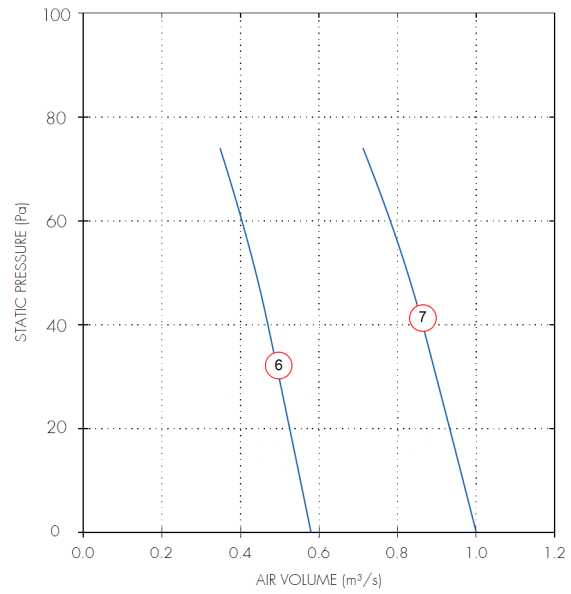

Dia.	Motor Phase	Stock Ref	Poles	r.p.m	IP Rating	Curve Ref.	0	m ³ /s @ Pa				Motor kW	S.C. Amps	F.L.C Amps	dB(A) @ 3m
								50	100	150	200				
250	1	ESP25012	2	2440	IP44	1	0.46	0.4	0.31	0.14		0.12	1.15	0.54	59
315	1	ESP31512	2	2690	IP54	2	1.02	0.96	0.88	0.8	0.68	0.56	7.2	2.4	64
250	1	ESP25014	4	1340	IP44	3	0.21	0.12				0.04	0.3	0.16	44
315	1	ESP31514	4	1300	IP54	4	0.57	0.42				0.15	1.38	0.7	50
355	1	ESP35514	4	1330	IP54	5	0.96	0.76				0.19	1.45	0.84	53
315	3	ESP31534	4	1390	IP54	6	0.58	0.44				0.11	2.1	0.27	46
355	3	ESP35534	4	1370	IP54	7	1	0.83				0.17	1.35	0.37	49

For fans wired to reverse run, duty reduced by 30%. ESP25012, ESP31512 and ESP25014 not suitable for reverse airflow.

Sound Power Level Spectra dB (ref 10⁻¹² Watts)

Dia.	Motor Phase	Stock Ref	Poles	Spectrum	dB(A) @ 3m								
					63	125	250	500	1k	2k	4k	8k	
250	1	ESP25012	2	Inlet	69	70	76	76	70	70	67	59	57
250	1	ESP25012	2	Outlet	69	70	76	76	70	70	67	59	57
315	1	ESP31512	2	Inlet	69	73	79	74	74	76	73	66	61
315	1	ESP31512	2	Outlet	69	73	79	74	74	76	73	66	61
250	1	ESP25014	4	Inlet	70	72	63	58	54	52	45	35	41
250	1	ESP25014	4	Outlet	70	72	63	58	54	52	45	35	41
315	1	ESP31514	4	Inlet	70	68	66	61	60	62	58	51	47
315	1	ESP31514	4	Outlet	70	68	66	61	60	62	58	51	47
355	1	ESP35514	4	Inlet	65	70	67	65	64	64	62	55	50
355	1	ESP35514	4	Outlet	65	70	67	65	64	64	62	55	50
315	3	ESP31534	4	Inlet	64	67	69	63	62	60	58	53	47
315	3	ESP31534	4	Outlet	64	67	69	63	62	60	58	53	47
355	3	ESP35534	4	Inlet	58	73	63	64	64	65	64	58	50
355	3	ESP35534	4	Outlet	58	73	63	64	64	65	64	58	50

Performance Guide

400 to 630 dia. - 1 Phase - 4 Pole

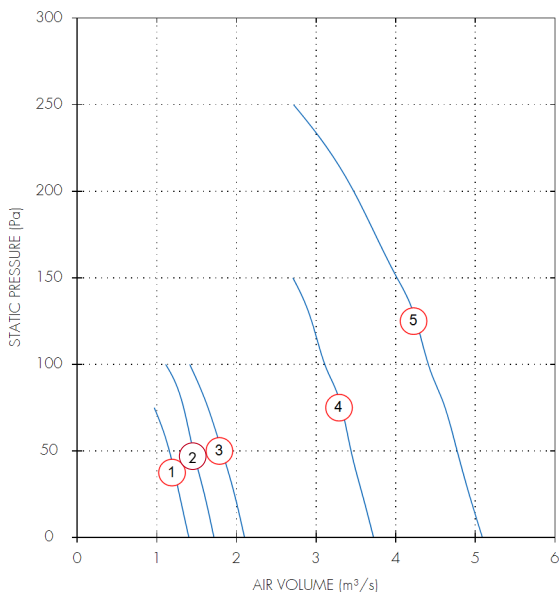

400 to 560 dia. - 3 Phase - 4 Pole

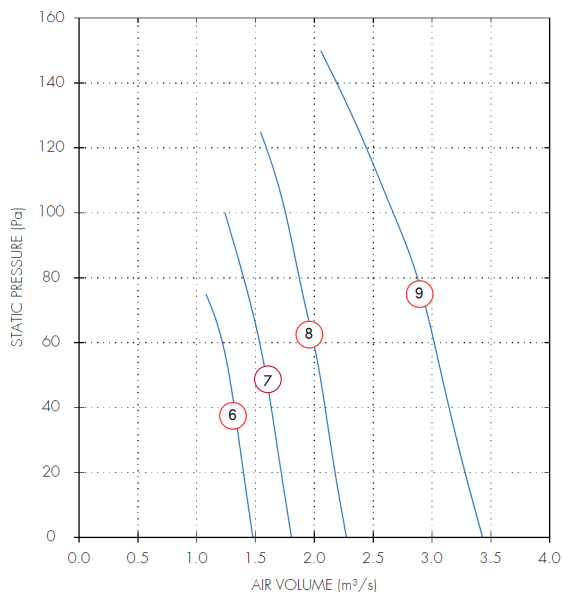

Dia.	Motor Phase	Stock Ref	Poles	r.p.m	IP Rating	Curve Ref.	m³/s @ Pa					Motor kW	S.C. Amps	F.L.C Amps	dB(A) @ 3m
							0	50	100	150	200				
400	1	ESP40014	4	1350	IP54	1	1.4	1.16				0.29	2.4	1.45	56
450	1	ESP45014	4	1370	IP54	2	1.72	1.46	1.11			0.36	3.6	1.6	61
500	1	ESP50014	4	1290	IP54	3	2.1	1.82	1.41			0.51	4.3	2.3	55
560	1	ESP56014	4	1320	IP54	4	3.72	3.44	3.11	2.71		1.35	9.3	6	63
630	1	ESP63014	4	1320	IP54	5	5.09	4.77	4.41	4.02	3.47	2.2	28	9.9	70
400	3	ESP40034	4	1350	IP54	6	1.48	1.27				0.26	2.1	0.56	51
450	3	ESP45034	4	1380	IP54	7	1.8	1.59	1.24			0.36	2.6	0.8	56
500	3	ESP50034	4	1380	IP54	8	2.27	2.05	1.75			0.55	4.2	1.05	58
560	3	ESP56034	4	1220	IP54	9	3.43	3.08	2.67	2.05		1.25	7.7	2.2	70

For fans wired to reverse run, duty reduced by 30%.

Sound Power Level Spectra dB (ref 10⁻¹² Watts)

Dia.	Motor Phase	Stock Ref	Poles	Spectrum	dB(A) @ 3m								
					63	125	250	500	1k	2k	4k	8k	
400	1	ESP40014	4	Inlet	70	72	67	66	65	65	64	56	51
400	1	ESP40014	4	Outlet	70	72	67	66	65	65	64	56	51
450	1	ESP45014	4	Inlet	69	76	73	72	70	71	70	62	57
450	1	ESP45014	4	Outlet	69	76	73	72	70	71	70	62	57
500	1	ESP50014	4	Inlet	65	75	69	70	70	71	69	62	56
500	1	ESP50014	4	Outlet	65	75	69	70	70	71	69	62	56
630	1	ESP63014	4	Inlet	82	86	79	79	80	78	75	70	64
630	1	ESP63014	4	Outlet	82	86	79	79	80	78	75	70	64
400	3	ESP40034	4	Inlet	62	73	65	65	67	69	67	60	53
400	3	ESP40034	4	Outlet	62	73	65	65	67	69	67	60	53
450	3	ESP45034	4	Inlet	65	82	75	76	73	72	69	62	58
450	3	ESP45034	4	Outlet	65	82	75	76	73	72	69	62	58
500	3	ESP50034	4	Inlet	67	71	69	72	70	71	68	61	56
500	3	ESP50034	4	Outlet	67	71	69	72	70	71	68	61	56
560	3	ESP56034	4	Inlet	85	79	77	76	76	75	72	66	61
560	3	ESP56034	4	Outlet	85	79	77	76	76	75	72	66	61

Performance Guide

630 to 710 dia. - 3 Phase - 4 Pole

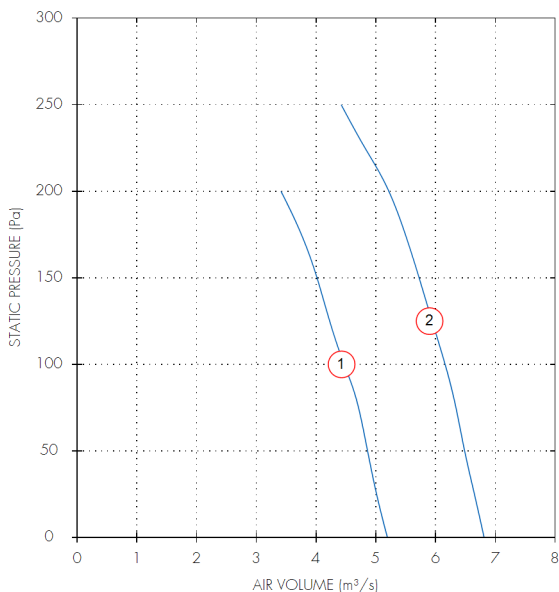

355 to 710 dia. - 1 Phase - 6 Pole

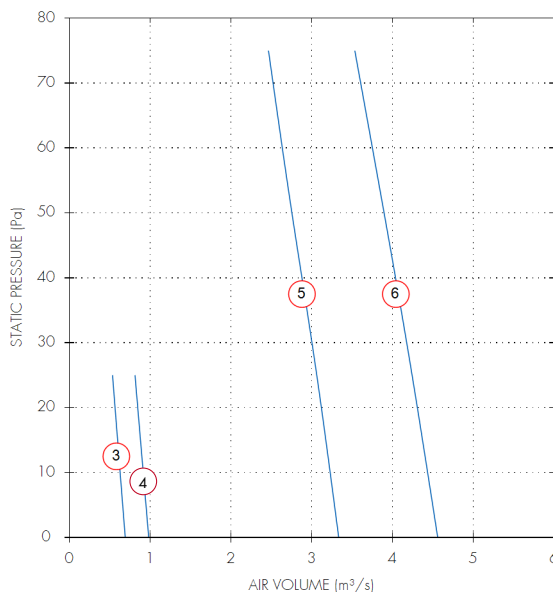

Dia.	Motor Phase	Stock Ref	Poles	r.p.m	IP Rating	Curve Ref.	m ³ /s @ Pa						Motor kW	S.C. Amps	F.L.C Amps	dB(A) @ 3m
							0	25	50	100	150	200				
630	3	ESP63034	4	1360	IP54	1	5.19	5.01	4.86	4.47	4.02	3.41	1.9	17	3.2	64
710	3	ESP71034	4	1290	IP54	2	6.81	6.65	6.49	6.16	5.72	5.22	2.9	20	5.3	72
355	1	ESP35516	6	950	IP54	3	0.69	0.53					0.09	1.2	0.46	44
400	1	ESP40016	6	940	IP54	4	0.98	0.81					0.1	1.4	0.48	45
630	1	ESP63016	6	880	IP54	5	3.33	3.06	2.75				0.6	5.3	2.7	57
710	1	ESP71016	6	850	IP54	6	4.56	4.24	3.89				0.89	8	4.1	60

For fans wired to reverse run, duty reduced by 30%.

Sound Power Level Spectra dB (ref 10⁻¹² Watts)

Dia.	Motor Phase	Stock Ref	Poles	Spectrum	dB(A) @ 3m								
					63	125	250	500	1k	2k	4k	8k	
630	3	ESP63034	4	Inlet	71	88	82	83	82	81	78	72	67
630	3	ESP63034	4	Outlet	71	88	82	83	82	81	78	72	67
710	3	ESP71034	4	Inlet	80	87	86	88	89	86	83	79	72
710	3	ESP71034	4	Outlet	80	87	86	88	89	86	83	79	72
355	1	ESP35516	6	Inlet	59	59	60	57	56	57	55	46	42
355	1	ESP35516	6	Outlet	59	59	60	57	56	57	55	46	42
400	1	ESP40016	6	Inlet	76	74	70	65	63	58	52	44	48
400	1	ESP40016	6	Outlet	76	74	70	65	63	58	52	44	48
630	1	ESP63016	6	Inlet	88	85	81	77	76	70	64	58	60
630	1	ESP63016	6	Outlet	88	85	81	77	76	70	64	58	60
710	1	ESP71016	6	Inlet	83	83	84	80	78	74	70	72	63
710	1	ESP71016	6	Outlet	83	83	84	80	78	74	70	72	63

Performance Guide

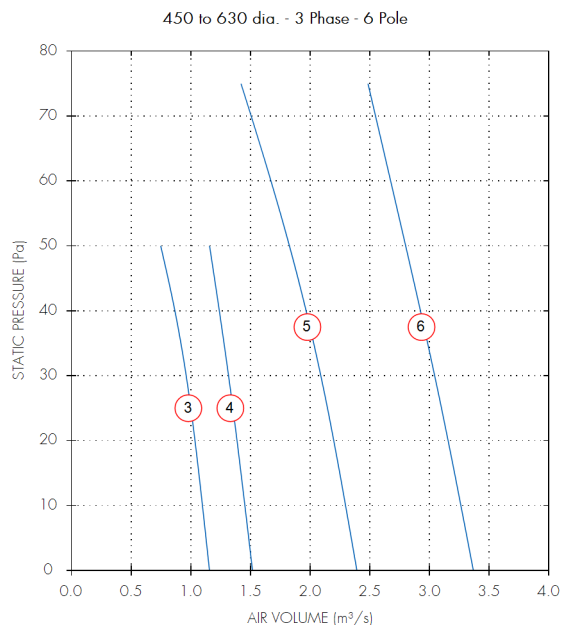
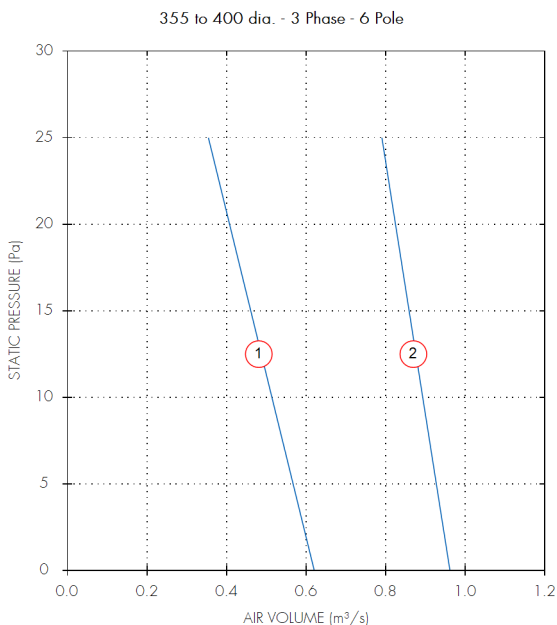

Dia.	Motor Phase	Stock Ref	Poles	r.p.m	IP Rating	Curve Ref.	m³/s @ Pa				Motor kW	S.C. Amps	F.L.C Amps	dB(A) @ 3m
							0	25	50	75				
355	3	ESP35536	6	910	IP54	1	0.62	0.35			0.09	0.5	0.25	45
400	3	ESP40036	6	920	IP54	2	0.96	0.79			0.11	0.9	0.28	50
450	3	ESP45036	6	890	IP54	3	1.16	1	0.75		0.12	1	0.28	51
500	3	ESP50036	6	900	IP54	4	1.52	1.35	1.16		0.23	1.5	0.56	56
560	3	ESP56036	6	860	IP54	5	2.39	2.14	1.83	1.42	0.36	1.75	0.74	56
630	3	ESP63036	6	890	IP54	6	3.37	3.1	2.8	2.48	0.59	3.6	1.3	59

For fans wired to reverse run, duty reduced by 30%.

Sound Power Level Spectra dB (ref 10⁻¹² Watts)

Dia.	Motor Phase	Stock Ref	Poles	Spectrum	dB								dB(A) @ 3m
					63	125	250	500	1k	2k	4k	8k	
355	3	ESP35536	6	Inlet	60	61	60	56	56	56	54	46	42
355	3	ESP35536	6	Outlet	60	61	60	56	56	56	54	46	42
400	3	ESP40036	6	Inlet	60	60	62	59	60	60	58	50	45
400	3	ESP40036	6	Outlet	60	60	62	59	60	60	58	50	45
450	3	ESP45036	6	Inlet	63	72	66	63	63	62	59	48	48
450	3	ESP45036	6	Outlet	63	72	66	63	63	62	59	48	48
500	3	ESP50036	6	Inlet	78	73	68	67	68	66	59	51	52
500	3	ESP50036	6	Outlet	78	73	68	67	68	66	59	51	52
560	3	ESP56036	6	Inlet	67	72	72	68	68	68	65	57	53
560	3	ESP56036	6	Outlet	67	72	72	68	68	68	65	57	53
630	3	ESP63036	6	Inlet	67	78	76	74	73	72	77	59	60
630	3	ESP63036	6	Outlet	67	78	76	74	73	72	77	59	60

Performance Guide

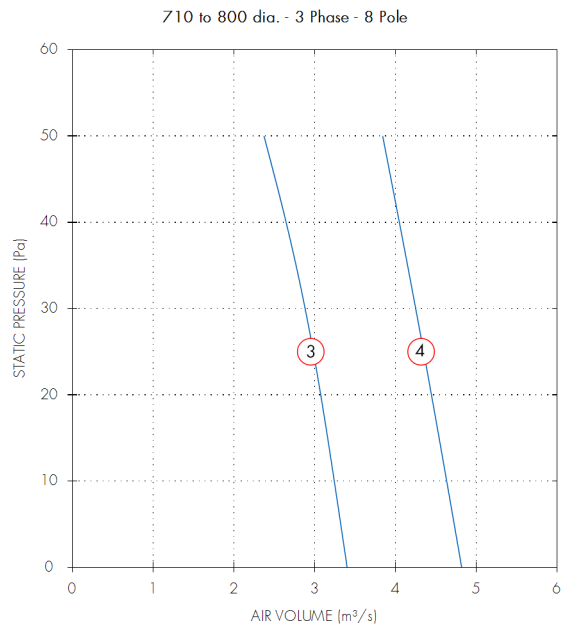
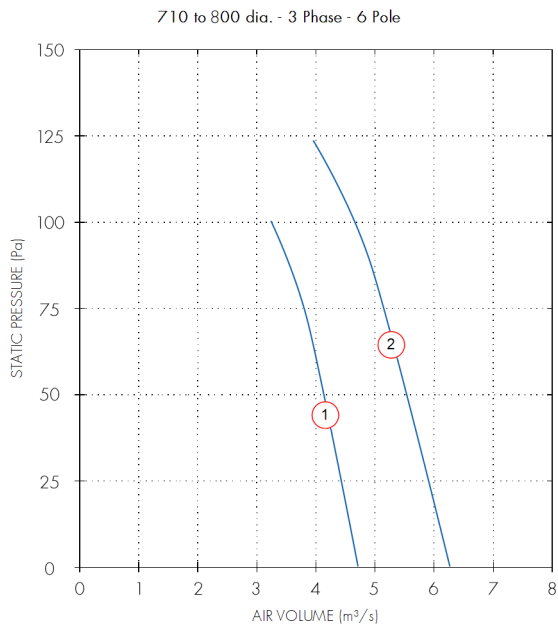

Dia.	Motor Phase	Stock Ref	Poles	r.p.m	IP Rating	Curve Ref.	m ³ /s @ Pa			Motor kW	S.C. Amps	F.L.C Amps	dB(A) @ 3m
							0	50	100				
710	3	ESP71036	6	860	IP54	1	4.71	4.11	3.29	1.1	7.7	2.2	62
800	3	ESP80036	6	900	IP54	2	6.3	5.58	4.67	1.4	9.8	2.7	64
710	3	ESP71038	8	630	IP54	3	3.4	2.37		0.43	3.3	1.1	55
800	3	ESP80038	8	670	IP54	4	4.82	3.84		0.69	5	1.75	58

For fans wired to reverse run, duty reduced by 30%.

Sound Power Level Spectra dB (ref 10⁻¹² Watts)

Dia.	Motor Phase	Stock Ref	Poles	Spectrum	dB								dB(A) @ 3m
					63	125	250	500	1k	2k	4k	8k	
710	3	ESP71036	6	Inlet	80	77	78	75	76	75	70	64	60
710	3	ESP71036	6	Outlet	80	77	78	75	76	75	70	64	60
800	3	ESP80036	6	Inlet	73	83	79	75	75	77	74	64	62
800	3	ESP80036	6	Outlet	73	83	79	75	75	77	74	64	62
710	3	ESP71038	8	Inlet	75	75	73	71	72	70	64	57	56
710	3	ESP71038	8	Outlet	75	75	73	71	72	70	64	57	56
800	3	ESP80038	8	Inlet	75	75	73	71	72	70	64	57	56
800	3	ESP80038	8	Outlet	75	75	73	71	72	70	64	57	56

Models & Accessories

Fan Stock Ref	Speed Controllers			Overload Stock Ref	Fan Stock Ref	Speed Controller Auto Transfor. Stock Ref	Starter Stock Ref	Overload Stock Ref	
	Elect 1ph Stock Ref	Auto Transfor. Stock Ref	Starter Stock Ref						
1 Phase - 4 Pole					3 Phase - 4 Pole				
ESP31514	SC5001	SPM5020	444744	444699	ESP31534	RDTK10	444747	444697	
ESP35514	SC5050TK	SPM5020	444744	444699	ESP35534	RDTK10	444747	444698	
ESP40014	SC5030TK	SPM5020	444744	444701	ESP40034	RDTK10	444747	444699	
ESP45014	SC5030TK	SPM5035	444744	444701	ESP45034	RDTK10	444747	444699	
ESP50014	SC5030TK	SPM5035	444744	444702	ESP50034	RDTK20	444747	444700	
ESP56014	SC5010TK	SPM5075	444744	444704	ESP56034	RDTK40	444747	444701	
ESP63014	-	-	444744	444706	ESP63034	RDTK40	444747	444702	
					ESP71034	RDTK70	444747	444703	
1 Phase - 6 Pole					3 Phase - 6 Pole				
ESP35516	SC5030TK	SPM5020	444744	444698	ESP35536	RDTK10	444747	444697	
ESP40016	SC5030TK	SPM5020	444744	444699	ESP40036	RDTK10	444747	444697	
					ESP45036	RDTK10	444747	444697	
					ESP50036	RDTK10	444747	444699	
					ESP56036	RDTK10	444747	444699	
ESP63016	SC5050TK	SPM5035	444744	444702	ESP63036	RDTK20	444747	444700	
ESP71016	SC5050TK	SPM5060	444744	444703	ESP71036	RDTK40	444747	444702	
					ESP80036	RDTK40	444747	444702	
					3 Phase - 8 Pole				
					ESP71038	RDTK20	444747	444700	
					ESP80038	RDTK20	444747	444701	

*Not suitable for voltage speed control. Inverter speed control with sine filters only.

Size	Roof Cowl Assembly Stock Ref	Louvre Shutter Stock Ref	Impeller Discharge Side Guard Stock Ref	Imp. Disch. Guard when used with LS shutter Stock Ref
250	RCZ300	LS250	10502325	10502375
315	RCZ300	LS315	10502325	10502375
355	RCZ300	LS350	10502375	10502450
400	RCZ400	LS400	10502450	10502525
450	RCZ400	LS450	10502525	10502630
500	RCZ500	LS500	10502525	10502630
560	RCZ500	LS560	10502630	10502630
630	RCZ630	LS630	10502630	10502800
710	RCZ630	LS710	10502800	10502800
800	RCZ800	LS800	10502800	105021000

Note:

- The Standard roof cowl colour is BS 00A 05 (Goose Wing Grey), for all special B.S. or RAL colours contact Vent-Axia.
- When speed control is required a 5 step auto transformer speed controller is recommended, to ensure low noise levels.
- All 3 phase models are suitable for frequency inverter speed control.
- Vent-Axia only recommends using inverters with integral sine filters for reliable operation.